



ELECTROCHEMICAL STUDIES ON THE CORROSION RESISTANCE OF 18 K GOLD IN ARTIFICIAL SALIVA, IN THE ABSENCE AND PRESENCE OF GEMER-2 TABLET (ORALLY TAKEN BY TYPE 2 DIABETES)

**S. Christina Joycee,^[a] K. Abiraami,^[a] M. Archana Devi,^[a] K. Chithra,^[a] J. Ezhil Vanisha,^[a]
A. James Juliet Mary,^[a] K. Jasmine Emarancia,^[a] S. Jeya Priya,^[a] M. Kowsalya,^[a] A. Lethicia
Amalrani,^[a] M. Logeshwari^[a] and Susai Rajendran^{*[a]}**

Keywords: biomaterial; artificial saliva; corrosion resistance; Gold, Gemer-2 tablet; electrochemical studies.

The corrosion resistance of 18 K gold in artificial saliva, in the absence and presence of Gemer-2 Tablet (orally taken by type 2 Diabetes) has been evaluated by polarization study and AC impedance spectra. Polarisation study reveals that in the presence of Gemer-2, LPR value increases and corrosion current decreases. That is in presence of Gemer-2, the corrosion resistance of 18K Gold in artificial saliva increases. AC impedance study reveals that in the presence of Gemer-2, R_t value increases and C_{dl} decreases. That is in the presence of Gemer-2 the corrosion resistance of 18 K Gold in AS increases. It is concluded that people clipped with orthodontic wire made of 18K Gold need not hesitate to take Gemer-2 orally.

* Corresponding Authors

E-Mail: susairajendran@gmail.com, joydgl@gmail.com

[a] Corrosion Research Centre, PG Department of Chemistry,
Amala Annai Nagar, Thamarapadi, India.

After conventional glow-discharge nitriding, they have observed an increase in corrosion resistance of AISI304 steel.³

The corrosion resistance of titanium alloys in synthetic saliva has been studied by Affi et al.⁴ The experiments have been carried out at various temperatures. Interesting observations were made. It has been observed that under these conditions the hardness of the material decreased and the corrosion rate of orthodontic wires increased.⁴

The influence of snakefruit extract in controlling the inhibitive release of chromium and nickel ion from stainless steel orthodontic wire in saliva has been studied by Erwanyah and Susilowati.⁵

The influence of oral antiseptics on the corrosion of nickel–titanium (NiTi) alloys with various coating has been investigated by Rincic-Mlinaric et al. It is observed that in most cases changes of mechanical characteristics induced by antiseptics are small and would not have a clinically significant impact.⁶

The influence of simulated erosive conditions on the frictional behavior of diverse orthodontic bracket-wire combinations have been studied by Stefański et al.⁷ It has been noted that erosive conditions do not change the frictional behavior of SS, Ni-Ti and TMA orthodontic archwires at a clinically significant level.

Simionescu et al. have investigated corrosion resistance of 316L stainless steel for orthodontic applications in artificial saliva. They have employed electrochemical studies for this purpose. It is concluded that the corrosion resistance is high when pH is low (acidic condition) and chloride ion concentration is less.⁸ It has been concluded that snakefruit

INTRODUCTION

Symmetrical and regularly arranged objects are beautiful. Especially regularly arranged teeth are attractive and leads to beautiful smiles. In some people the teeth are not regularly arranged by birth. To regularise the growth of teeth people, consult the dentists. They recommend the use of orthodontic wires made of various alloys such as SS316L, SS18/8, 22K gold etc. After the clipping of these orthodontic wires, people orally take many of items, tablets and juices. Hence the orthodontic wires may undergo corrosion. Many research activities have been undertaken in this regard.

The corrosion resistance of AISI 316L stainless steel orthodontic archwire in many fruit juices has been carried out by electrochemical studies. The surface morphology of protective film has been analysed by Scanning Electron Microscopy and Atomic force microscopy.¹

Sharma et al. have used electrochemical studies such as polarization study and AC impedance spectra to investigate the corrosion behaviour of orthodontic archwire made of AISI 316L stainless steel in presence of chloride ions and many fruit juices. The protective film has been analysed by Scanning electron microscopy.²

Kamiński et al., have used electrochemical studies to study the corrosion behaviour orthodontic arch-wires made of AISI304 steel in simulated saliva.

seeds extract controlled the release of chromium and nickel ion from stainless steel orthodontic wire in saliva.

Employing electrochemical studies, Nahusona and Koriston have studied the corrosion behaviour of stainless-steel orthodontic wire in saliva in presence of watermelon rind extract. It is observed that the corrosion resistance of stainless steel orthodontic wire in saliva in presence of watermelon rind extract increases.⁹ Hence it implies that people clipped with orthodontic wire made of stainless steel need not hesitate to take watermelon rind extract orally.

Musa Trolic et al. have investigated the corrosion resistance of three types of NiTi orthodontic wires and stainless steel in simulated saliva. Influence of *Lactobacillus reuteri* has also been studied. It was observed that the added substances from probiotic supplement are responsible for the localized corrosion of the studied wires.¹⁰

Present work is undertaken to investigate the corrosion resistance of 18 K Gold in artificial saliva in the absence and presence of Gemer-2 Tablet, orally intaken by type 2 Diabetes, by electrochemical studies such as polarisation study and AC impedance spectra.

EXPERIMENTAL

Gemer-2 tablet

Gemer-2 is a drug that treats patients suffering from type 2 diabetes. It is also used in combination with other antidiabetic medicines. This drug is a type of sulfonylurea antidiabetic medicine that helps the pancreas in releasing insulin. This tablet reduces the blood sugar level. It belongs to a class of drugs known as sulfonylureas.¹¹

Preparation of artificial saliva

The preparation of artificial saliva was done using the composition of Fusayama-Meyer artificial saliva (AS). Artificial saliva was prepared in laboratory and the composition of artificial saliva was as follows: KCl-0.4 g L⁻¹, NaCl-0.4 g L⁻¹, CaCl₂·2H₂O - 0.906 g L⁻¹, NaH₂PO₄·2H₂O - 0.690 g L⁻¹, Na₂S·9H₂O - 0.005 g L⁻¹, urea - 1 g L⁻¹.

Electrochemical studies

Electrochemical studies are used to measure the corrosion resistance of metals and alloys in various media.¹²⁻²⁷ The corrosion resistance of 18K gold in artificial saliva, in the absence and presence of Gemer-2 has been evaluated by electrochemical studies such as polarization study and AC impedance spectra.

Potentiodynamic polarization study

A CHI 660 A workstation model was used in the electrochemical studies. Polarization study was carried out using a three electrodes cell assembly (Scheme A). 18K Gold was used as working electrode, platinum as counter electrode and saturated calomel electrode (SCE) as reference

electrode. After having done iR compensation, polarization study was carried out, at a sweep rate of 0.01 V s⁻¹.

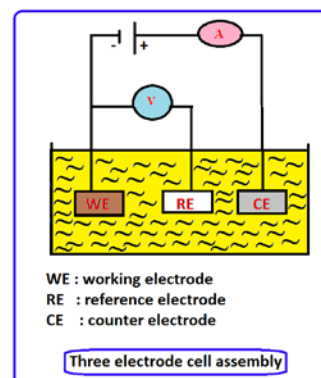

Scheme A. Three electrode cell assembly

The corrosion parameters such as linear polarization resistance (*LPR*), corrosion potential E_{corr} , corrosion current I_{corr} and Tafel slopes [b_a (anodic Tafel slope) and b_c (cathodic Tafel slope)] were measured.

AC impedance spectra

In the present investigation the same instrumental set-up used for polarization study was used to record AC impedance spectra also. A time interval of 5 to 10 min was given for the system to attain a steady state open circuit potential. The real part (Z') and imaginary part (Z'') of the cell impedance were measured in ohms at various frequencies. AC impedance spectra were recorded with initial $E(V) = 0$, high frequency (1×10^5 Hz), low frequency (1 Hz), amplitude (V) = 0.005 and quiet time (s) = 2. From Nyquist plot the values of charge transfer resistance (R_t) and the double layer capacitance (C_{dl}) were calculated. From Bode plot impedance values were derived,

RESULTS AND DISCUSSION

Influence of Gemer-2 on corrosion resistance of 18K gold in artificial saliva

Corrosion resistance of orthodontic wire made of 18 K Gold in presence of Gemer-2 Tablet has been investigated by electrochemical studies, namely, polarisation study and AC impedance spectra. Interesting results have been obtained. They are presented and discussed in this section.

It is a fact that when corrosion resistance of a metal or alloy increases, the linear polarization resistance (*LPR*) value increases and corrosion current (I_{corr}) value decreases. Similarly, when corrosion resistance value increases. Charge transfer resistance value increases, impedance value increases and double layer capacitance value decreases (Scheme B). This is due to the fact that when a protective film is formed on the metal surface the flow of corrosive ions on to the metal surface is prevented. Further the loss of electron from the metal surface is also prevented.¹²⁻²⁷

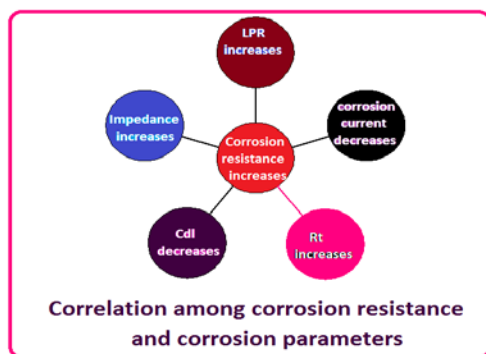

Scheme B. Correlation among corrosion resistance and corrosion parameters

Analysis of polarization study

The polarization curves of 18K gold immersed in various test solutions are shown in Figures 1 and 2. Corrosion resistance of 18K gold in artificial saliva in presence of Gemer-2 is given in the Table 1. The linear polarization resistance values of 18K gold artificial saliva in the absence and presence of Gemer-2 tablet are compared graphically in Figure 3.

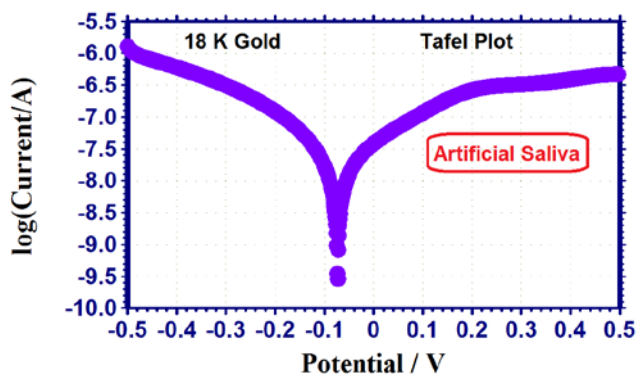

Figure 1. Polarization curve of 18K gold immersed in artificial saliva

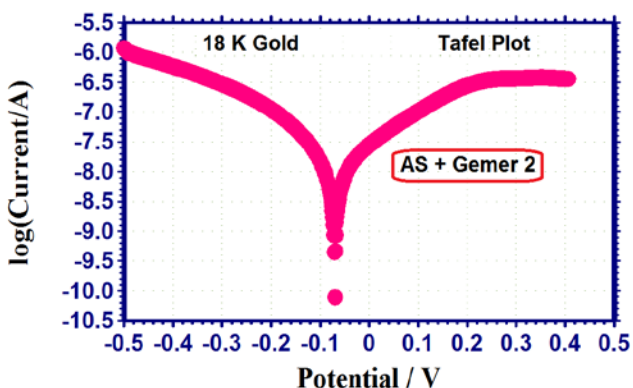

Figure 2. Polarization curve of 18K gold immersed in artificial saliva in the presence of Gemer-2

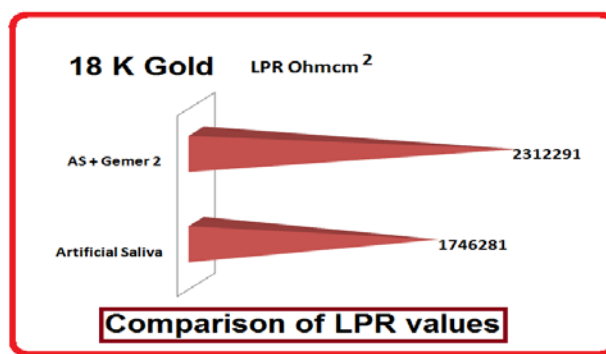

Figure 3. Column chart of linear polarization resistance value of 18 K Gold in the absence and presence of Gemer-2

When 18K gold is immersed in artificial saliva, E_{corr} (corrosion potential) is -0.072 V vs SCE . The corrosion current (I_{corr}) is $2.166 \times 10^{-8} \text{ A cm}^{-2}$. Cathodic Tafel slope (b_c) is $6.735 \text{ V decade}^{-1}$. The anodic Tafel slope (b_a) is $4.758 \text{ V decade}^{-1}$. The linear polarization resistance (LPR) is 1746281 Ohm cm^2 .

Influence of Gemer-2

When Gemer-2 (500 ppm) is added to artificial saliva, the corrosion potential (E_{corr}) is -0.069 V vs SCE . The corrosion current (I_{corr}) is $1.500 \times 10^{-8} \text{ A cm}^{-2}$. Cathodic Tafel slope (b_c) is $7.327 \text{ V decade}^{-1}$. The anodic Tafel slope (b_a) is $5.211 \text{ V decade}^{-1}$. The linear polarization resistance (LPR) is 2312291 Ohm cm^2 . It is observed from the Table 1 that when Gemer-2 is added to AS, the LPR value increases from 1746281 Ohm cm^2 to 2312291 Ohm cm^2 . The corrosion current decreases from 2.166×10^{-8} to $1.500 \times 10^{-8} \text{ A cm}^{-2}$.

This indicates that in presence of Gemer-2, the corrosion resistance of 18K gold in artificial saliva increases (Scheme B). Hence people clipped with orthodontic wire made of 18K gold need not hesitate to take Gemer-2 orally.

Implication

Hence people clipped with orthodontic wire made of 18 K Gold need not hesitate to take Gemer-2 Tablet orally.

Analysis of AC impedance spectra

The AC impedance parameters such as charge transfer resistance (R_t), double layer capacitance (C_{dl}) and impedance values of 18K gold immersed in AS in the absence and presence of Gemer-2 are given in Table 2. The Nyquist plots are shown in Figures 4 and 5.

The Bode plots are shown in Figures 6 and 7. The charge transfer resistance and double layer capacitance values are derived from Nyquist plot. The impedance values are derived from Bode plot.

Table 1. Corrosion parameters of 18 K Gold immersed in artificial saliva (AS) in the absence and presence of Gemer-2 (500 ppm) obtained by polarization study

System	E_{corr} , V (SCE)	b_e , V decade ⁻¹	b_a , V decade ⁻¹	LPR, Ω cm ²	I_{corr} , A cm ²
Artificial saliva(AS)	-0.072	6.735	4.758	1746281	2.166×10^{-8}
AS + Gemer-2	-0.069	7.327	5.211	2312291	1.500×10^{-8}

Table 2. Corrosion parameters of SS 18/8 immersed in Artificial Saliva (AS) in the absence and presence of Gemer-2 (500 ppm) obtained by AC impedance spectra

System	R_t , ohm cm ²	C_{dl} , Fcm ⁻²	Impedance, log(Z ohm ⁻¹)
Artificial saliva	113500	4.493×10^{-11}	5.368
AS + Gemer-2	217900	2.341×10^{-11}	5.613

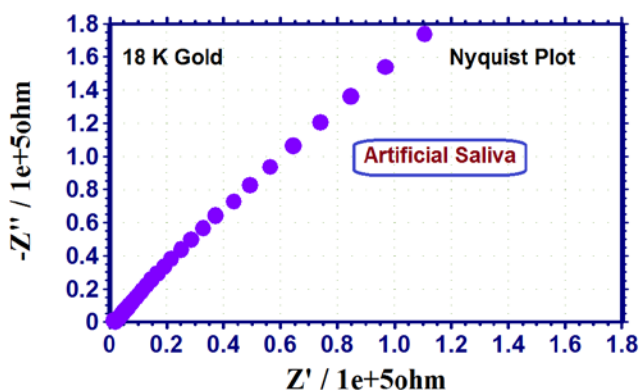
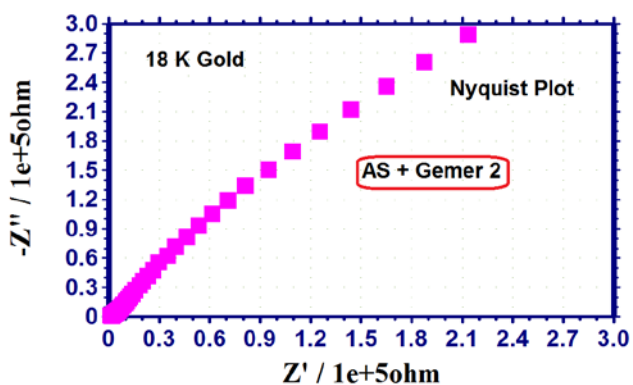
**Figure 4.** AC impedance spectrum of 18K gold immersed in artificial saliva (Nyquist Plot)**Figure 5.** AC impedance spectrum of 18K gold immersed in artificial saliva in the presence of Gemer-2 (Nyquist Plot)

The charge transfer values of SS18/8 in artificial saliva in the absence and presence of Gemer-2 tablet are compared graphically in Figure 8.

When 18K gold is immersed in artificial saliva, R_t (charge transfer resistance) is 113500 Ohm cm². C_{dl} (double layer capacitance) is 4.493×10^{-11} F cm⁻². Impedance is 5.368 log Z ohm⁻¹.

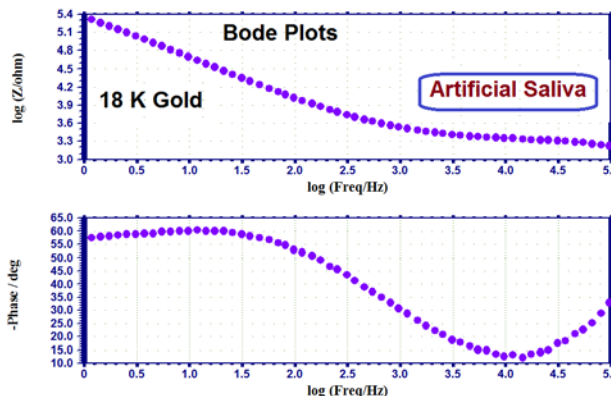
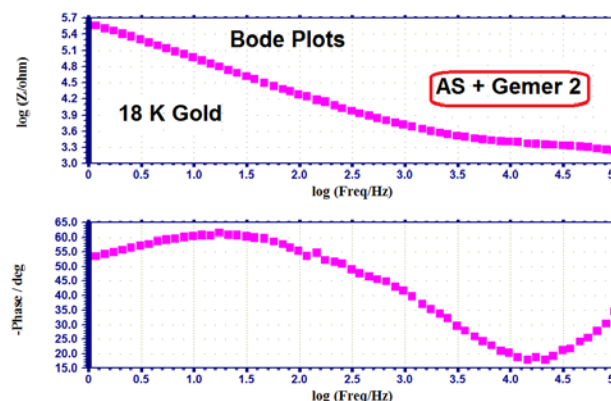
**Figure 6.** AC impedance spectrum of 18K gold immersed in artificial saliva (Bode plot)**Figure 7.** AC impedance spectrum of 18K gold immersed in artificial saliva in the presence of Gemer-2(Bode plot)

Influence of Gemer-2

When Gemer-2 is added to artificial saliva, the R_t (charge transfer resistance) is 217900 Ohm cm². C_{dl} (double layer capacitance) is 2.341×10^{-11} F/cm². Impedance is 5.613 log (Z ohm⁻¹). It is observed from the Table 3 that when Gemer-2 is added to AS, the R_t value increases from 113500 to 217900 Ohm cm². Double layer capacitance decreases from 4.493×10^{-11} to 2.341×10^{-11} F cm⁻². This indicates that in presence of Gemer-2, the corrosion resistance of 18K gold in artificial saliva increases. Hence people clipped with orthodontic wire made of 18K gold need not hesitate to take Gemer-2 orally.

Implication

Hence people clipped with orthodontic wire made of 18K gold need not hesitate to take Gemer-2 orally.

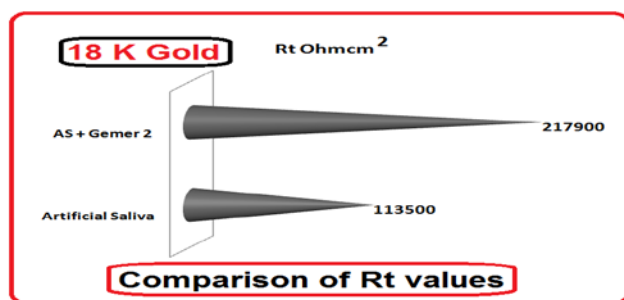

Figure 8. Comparison of charge transfer resistance (R_t) values of 18K gold in the absence and presence of Gemer-2

CONCLUSIONS

- The corrosion resistance of 18K gold in artificial saliva, in the absence and presence of Gemer-2 has been evaluated by polarization study and AC impedance spectra.
- Polarisation study reveals that in the presence of Gemer-2, LPR value increases and corrosion current decreases.
- That is in presence of Gemer-2, the corrosion resistance of 18K gold in artificial saliva increases.
- AC impedance study reveals that in the presence of Gemer-2, R_t value increases and C_{dl} decreases.
- That is in the presence of Gemer-2 the corrosion resistance of 18K gold in AS increases.
- It is concluded that people clipped with orthodontic wire made of 18K gold need not hesitate to take Gemer-2 orally

ACKNOWLEDGMENT

The authors are thankful to their respective managements for their help and encouragement. Special thanks to Rev. Dr. Antony Pushpa Ranjitham (Superior General), Rev. Sr. Thanaseeli Sengole (Asst. General), Rev. Sr. M. Margaret Inbaseeli (College Secretary), Rev. Dr. Pramila (Principal), Rev. Sr. Gnana Soundari (Provincial) and Mrs J. Antony Justina Mary (Vice Principal) for their Prayer and Blessings.

REFERENCES

- ¹Ziębowski, B., Woźniak, A., Ziębowski, A., Ziemińska-Buczyńska, A., Analysis of the surface geometry of the orthodontic archwire and their influence on the bacterial adhesion, *J. Achiev. Mater. Manuf. Eng.*, **2019**, 93(1-2), 32-40. <https://doi.org/10.5604/01.3001.0013.4139>
- ²Sharma, M. R., Mahato, N., Cho, M. H., Chaturvedi, T. P., Singh, M. M., Effect of fruit juices and chloride ions on the corrosion behavior of orthodontic archwire, *Mater. Techn.*, **2019**, 34(1), 18-24. <https://doi.org/10.1080/10667857.2018.1473992>
- ³Kamiński, J., Małkiewicz, K., Rębiś, J., Wierzchoń, T., The effect of glow discharge nitriding on the corrosion resistance of stainless steel orthodontic arches in artificial saliva solution, *Arch. Metall. Mater.*, **2020**, 65(1), 375-384. DOI: 10.24425/amm.2020.131740
- ⁴Affi, J., Ihsan, F., Fajri, H., Gunawarman, Corrosion Behavior Of New Type Titanium Alloy As Candidate For Dental Wires In Artificial Saliva On Fluctuating Temperatures, *IOP Conf. Series: Mater. Sci. Eng.*, **2019**, 547(1), 012022. <https://doi.org/10.1088/1757-899X/547/1/012022>
- ⁵Erwansyah, E., Susilowati, C., The effect of snakefruit extract (Salacca Zalacca) in inhibiting the release of chromium (Cr) and nickel (Ni) ion from stainless steel orthodontic wire to saliva, *Int. J. Appl. Pharm.*, **2019**, 11(4), 33-36. <https://doi.org/10.22159/ijap.2019.v11s4.35286>
- ⁶Rincic Mlinaric, M., Karlovic, S., Ciganj, Z., Acev, D.P., Pavlic, A., Spalj, S., Oral antiseptics and nickel-titanium alloys: mechanical and chemical effects of interaction, *Odontology*, **2019**, 107(2), 150-157. <https://doi.org/10.1007/s10266-018-0387-9>
- ⁷Stefański, T., Kloc-Ptaszna, A., Postek-Stefańska, The effect of simulated erosive conditions on the frictional behavior of different orthodontic bracket-wire combinations, *Dental Med. Probl.*, **2019**, 56(2), 173-177. <https://doi.org/10.17219/dmp/105832>
- ⁸Simionescu, N., Ravoiu, A., Benea, L., Electrochemical in vitro Properties of 316L Stainless Steel for Orthodontic Applications, *Rev. Chimie*, **2019**, 70(4), 1144-1148. <https://doi.org/10.37358/RC.19.4.7081>
- ⁹Nahusona, D.R., Koriston, P., The effectiveness of watermelon rind extract as corrosion inhibitor in stainless steel orthodontic wire, *Int. J. Appl. Pharm.*, **2019**, 11(4), 22-25. <https://doi.org/10.22159/ijap.2019.v11s4.35283>
- ¹⁰Musa-Trolic, I., Serdarevic, N.L., Todoric, Z., Budimir, A., Spalj, S., Otmacic-Curkovic, H., Corrosion of orthodontic archwires in artificial saliva in the presence of *Lactobacillus reuteri*, *Surf. Coatings Tech.*, **2019**, 370, 44-52. <https://doi.org/10.1016/j.surfcoat.2019.04.081>
- ¹¹<https://www.lybrate.com/medicine/gemer-2-tablet>
- ¹²Nagalakshmi, N., Nagarajan, L., Rathish, R.J., Prabha, S.S., Vijaya, N., Jeyasundari, J., Rajendran, S., Corrosion Resistance Of SS316l In Artificial Urine In Presence Of D-Glucose, *Int. J. Nano Corr. Sci. Eng.*, **2014**, 1, 39.
- ¹³Thangakani, J. A., Rajendran, S., Sathiyabama, J., Joany, R. M., Rathish, R. J., Prabha, S. S., Inhibition of Corrosion of Carbon Steel in Aqueous Solution Containing Low Chloride Ion by Glycine – Zn²⁺ System, *Int. J. Nano. Corr. Sci. Engg.*, **2014**, 1, 50.
- ¹⁴Nithya, A., Shanthi, P., Vijaya, N., Rathish, R.J., Prabha, S.S., Joany, R.M., Rajendran, S., Inhibition of Corrosion of Aluminium by an Aqueous Extract of Beetroot (Betanin), *Int. J. Nano Corr. Sci. Engg.*, **2015**, 2, 1.
- ¹⁵Mary, A. C. C., Rajendran, S., Al-Hashem, H., Rathish, R. J., Umasankareswari, T., Jeyasundari, J., Inhibition of Corrosion of Carbon Steel in Aqueous Solution Containing Low Chloride Ion by Glycine – Zn²⁺ System, *Int. J. Nano Corr. Sci. Engg.*, **2015**, 1, 42.
- ¹⁶Anandan, A., Rajendran, S., Sathiyabama, J., Sathiyaraj, D., Influence of some tablets on corrosion resistance of orthodontic wire made of SS 316L alloy in artificial saliva, *Int. J. Corros. Scale Inhib.*, **2017**, 6(2), 132-141. doi: [10.17675/2305-6894-2017-6-2-3](https://doi.org/10.17675/2305-6894-2017-6-2-3)
- ¹⁷Akalezi, C. O., Ogukwe, C. E., Ejele, E. A., Oguzie, E. E., Mild steel protection in acidic media using *Mucuna pruriens* seed extract, *Int. J. Corros. Scale Inhib.*, **2016**, 5(2), 132-146. doi: [10.17675/2305-6894-2016-5-2-3](https://doi.org/10.17675/2305-6894-2016-5-2-3)
- ¹⁸Onat, T. A., Yiğit, D., Nazır, H., Güllü, M., Dönmez, G., Biocorrosion inhibition effect of 2-aminopyrimidine derivatives on SRB, *Int. J. Corros. Scale Inhib.*, **2016**, 5(3), 273-281. <https://doi.org/10.17675/2305-6894-2016-5-3-7>
- ¹⁹Fouda, A. S., El-Morsy, M. A., El-Barbary, A. A., Lamloom, L. E., Study on corrosion inhibition efficiency of some quinazoline derivatives on stainless steel 304 in hydrochloric acid solutions, *Int. J. Corros. Scale Inhib.*, **2016**, 5(2), 112-131. <https://doi.org/10.17675/2305-6894-2016-5-2-2>

- ²⁰Vigdorovich, V. I., Tsygankova, L. E., Tanygina, E. D., Yu Tanygin, A., Shel, N. V., Preservative materials based on vegetable oils for steel protection against atmospheric corrosion. I. Colza oil, *Int. J. Corros. Scale Inhib.*, **2016**, *5(1)*, 59–65. doi: [10.17675/2305-6894-2016-5-1-5](https://doi.org/10.17675/2305-6894-2016-5-1-5)
- ²¹Devi, P. N., Sathiyabama, J., Rajendran, S., Study of surface morphology and inhibition efficiency of mild steel in simulated concrete pore solution by lactic acid–Zn²⁺ system, *Int. J. Corros. Scale Inhib.*, **2017**, *6(1)*, 18–31. doi: [10.17675/2305-6894-2017-6-1-2](https://doi.org/10.17675/2305-6894-2017-6-1-2)
- ²²Ikhmal, W. M. K. W. M., Yasmin, M. Y. N., Maria, M. F. F., Syaizwadi, S. M., Rafizah, W. A. W., Sabri, M. G. M., Zahid, B. M., Evaluating the performance of *Andrographis paniculata* leaves extract as additive for corrosion protection of stainless steel 316L in seawater, *Int. J. Corros. Scale Inhib.*, **2020**, *9(1)*, 118-133. doi: [10.17675/2305-6894-2020-9-1-7](https://doi.org/10.17675/2305-6894-2020-9-1-7)
- ²³Al-Moubaraki, A.H., Awaji, H., 1-X-4-[4'-(–OCH₃)-Styryl] pyridinium iodides, potent inhibitors for stainless steel corrosion in 2 M HCl acid solutions, *Int. J. Corros. Scale Inhib.*, **2020**, *9(2)*, 460-501. doi: [10.17675/2305-6894-2020-9-2-5](https://doi.org/10.17675/2305-6894-2020-9-2-5)
- ²⁴Dohare, P., Chauhan, D. S., Quraishi, M. A., Expired Podocip drug as potential corrosion inhibitor for carbon steel in acid chloride solution, *Int. J. Corros. Scale Inhib.*, **2018**, *7(1)*, 25-37. doi: [10.17675/2305-6894-2018-7-1-3](https://doi.org/10.17675/2305-6894-2018-7-1-3)
- ²⁵Kavipriya, K., Sathiyabama, J., Rajendran, S., Nagalakshmi, R., The inhibitive effect of diethylenetriamine-pentamethylene phosphonic acid on the corrosion of carbon steel in seawater, *Eur. Chem. Bull.*, **2013**, *2(7)*, 423-429. DOI: [http://dx.doi.org/10.17628/ecb.2013.2.423-429](https://dx.doi.org/10.17628/ecb.2013.2.423-429)
- ²⁶Abuthahir, S., Nasser, J. A., Rajendran, S., Electrochemical and surface analysis studies on corrosion inhibition of mild steel, *Eur. Chem. Bull.*, **2013**, *2(11)*, 932-935. <http://dx.doi.org/10.17628/ecb.2013.2.932-935>
- ²⁷Rajendran, S., Duraiselvi, K., Prabhakar, P., Pandiarajan, M., Tamilmalar, M., Joseph Rathish, R., Corrosion resistance of commercial aluminium in simulated concrete pore solution in presence of curcumin extract, *Eur. Chem. Bull.*, **2013**, *2(11)*, 850-854, <http://dx.doi.org/10.17628/ecb.2013.2.850-854>

Received: 20.09.2020.

Accepted: 09.10.2020.